

TECHNICAL DATA SHEET

VALSIR® DRAINAGE SYSTEMS

RAINPLUS



valsir®
QUALITY FOR PLUMBING

RAINPLUS

Description

Rainplus® system is used to drain rainwater from the roofs of medium to large size buildings. The system exploits the building height as the driving force to generate high speed flows and to allow the entire flow of water to be directed to any part of the building whatsoever, thus enabling the most modern rainwater harvesting systems to be installed.

The system is composed of special siphonic outlets made up of a body, a flange and an anti-vortex cover in aluminum covered with a special protective UV resistant resin, an anti-leaf grating in polypropylene with a load resistance of at least 200 kg and a socket for connection to Valsir HDPE pipes with a safety device and double ring seal.

The siphonic outlets are constructed and tested to ASME A112.6.9 and EN 1253 and must be connected to Valsir HDPE high density polyethylene pipes that are sized to operate under negative pressures, at high flow rates and completely full to prevent air from entering when the design rainfall intensity value is reached.

The outlets are equipped with accessories that allow installation on roofs that are waterproofed with bitumen or other plastic materials or inside gutters or collection canals.

The system is equipped with fixed point brackets made of galvanized steel that withstand heavy loads and are equipped with a special anchoring that allows them to be blocked onto U-shaped support bars.

As well as supporting the pipes, the bracketing system must also be capable of absorbing the expansions of the Valsir HDPE pipes, which are generated due to fluctuations in the ambient temperature.

Pipes and fittings

The Valsir® HDPE product line is composed of pipes, fittings and accessories to create waste and ventilation systems as well as rainwater drainage systems that operate under negative pressures.

Valsir® HDPE is suitable for above ground installations thanks to its resistance to UV rays, as well as underground installation and inside concrete. It is widely used for waste systems inside buildings for civil and industrial usage, in hotels, hospitals, laboratories and industrial plants.



Characteristics

- Wide range of diameters from OD 32 mm to OD 315 mm and two types of wall thickness SDR 26 and SDR 33.
- Extremely fast and easy to install thanks to the light weight of the products, the numerous connection methods available and the possibility of prefabrication.
- Wide range of special fittings that allow the construction of any type of system and transition fittings for the connection to waste systems in different materials such as cast iron, PP, PVC, etc.
- High chemical resistance and excellent compatibility with the majority of substances normally present in civil and industrial waste waters. HDPE is immune from the attack by microorganisms and it is not affected by corrosion due to stray currents.
- An high abrasion resistance and an extremely smooth internal surface guarantee minimal pressure losses and the absence of deposit formation.
- The pipes are stabilized to reduce dimensional variations and are coloured with carbon black which makes the system resistant to UV rays.

Figure Layering of the pipe.

High density polyethylene

The pipes and fittings are made of high density, UV light resistant, polyethylene that guarantees high mechanical resistance, excellent abrasion resistance, extremely smooth surfaces and high resistance to chemical agents.



Technical details

Table Typical technical details.

Property	Value	Test method
Pipe material	High density polyethylene PE 80	-
Fitting material	High density polyethylene PE 80	-
Colour	Black	-
Diameters	32÷315 mm	-
Application	High and low temperature waste and drainage systems inside the building, externally anchored to the walls of the building (application area B) or mounted inside the building and embedded inside the structure (application area D) and or for both installations (application area DB); ventilation for waste systems; rainwater drainage systems both gravity and under negative pressure.	-
Connections	Butt welding, electrofusion welding using a sleeve coupling, push-fit method with rubber seal, mechanical joint with flange, mechanical joint with screw fitting.	-
Minimum operating temperature	-40°C (-5°C for welding)	-
Maximum temperature of waste water	+95°C (intermittent) +80°C (continuous)	-
Minimum pressure ⁽¹⁾	-800 mbar (SDR 26) -450 mbar (SDR 33)	-
Maximum pressure ⁽²⁾	Without push-fit sockets or expansion sockets: +5 bar (SDR 26); +4 bar (SDR 33) With push-fit sockets or expansion sockets: +0.5 bar	-
Composition of waste water	pH 0÷14	-
Density at 23°C	> 945 kg/m ³	EN ISO 1183-2
Melt Index 190°C/5.0 kg	< 1.1 g/10 min	EN ISO 1133
Elasticity modulus	1000 MPa	ISO 527-2
Tensile strength	22 MPa	ISO 527-2
Ultimate elongation	≥ 350 %	ISO 6259-3
Carbon black content	≥ 2.0 %	ASTM D 1603
Thermal stability (OIT) at 200°C	≥ 20 min	EN 728
Crystalline melting temperature	≥ 130°C	EN 728
Linear heat expansion coefficient	0.20 mm/m·k	-
UV resistance	Suitable for storage outdoors as well as applications with exposure to sunlight	-
Halogen content	Halogen-free	-
Fire resistance	Class M4 Class B2 Euroclass E	NF P 92-505 DIN 4102, DIN 19535-10 EN 13501-1
Reference construction standard	EN 1519-1 - AS/NZS 5065 - AS/NZS 4401 - SN S92010 SN S92012 - DIN 19537-2 - DIN 19535-10 - NBK 8 SI 4479-1 - SANS 8770	-
Packaging	Pipes in wooden frames with strapping Fittings in cardboard boxes	-

(1) Operating conditions at 20°C valid only for rainwater drainage systems under negative pressure (Rainplus syphonic drainage systems).

(2) Maximum pressures in relation to special applications not in compliance with EN 1519 considering a safety factor SF=1.25 and temperature of 20°C.

Application field

The Valsir® pipes and fittings in polyethylene meet the requirements of the EN 1519 Standard and can be installed inside buildings destined for residential and industrial usage and in particular for the following purposes:

- Waste pipes for domestic waste water (low and high temperature).
- Ventilation pipes connected to the waste pipes previously indicated.
- Discharge of rain water inside the structure of the building.

The EN 1519 Standard establishes different applications identified with a specific marking:

- The “B” marking identifies pipes and fittings used inside or outside the building but anchored to the wall. The use is limited to the S16 series, this series cannot be destined to underground applications of any type.
- The “D” marking identifies pipes and fittings underground used below the building at a distance no greater than 1 m from the same and connected to the building’s waste system.
- The “BD” marking identifies pipes and fittings destined for both uses as specified in the previous points. For this use nominal diameters equal to or greater than 75 mm belonging to the S 12.5 series, are allowed.

Dimensions

The diameters, the wall thickness and relative tolerances of the Valsir® pipes in high density polyethylene are indicated in the following table. These values are in compliance with those set by the standards currently in force.

Table Pipe dimensional characteristics.

Nominal diameter DN [mm]	External diameter OD [mm]	Thickness s [mm]	Series s	SDR	Application area
30	32 $^{+0.3}_0$	3.0 $^{+0.5}_0$	12.5/16	26/33	BD
40	40 $^{+0.4}_0$	3.0 $^{+0.5}_0$	12.5/16	26/33	BD
50	50 $^{+0.5}_0$	3.0 $^{+0.5}_0$	12.5/16	26/33	BD
56	56 $^{+0.5}_0$	3.0 $^{+0.5}_0$	12.5/16	26/33	BD
60	63 $^{+0.6}_0$	3.0 $^{+0.5}_0$	12.5/16	26/33	BD
70	75 $^{+0.7}_0$	3.0 $^{+0.5}_0$	12.5/16	26/33	BD
90	90 $^{+0.9}_0$	3.5 $^{+0.6}_0$	12.5	26	BD
100	110 $^{+1.0}_0$	4.2 $^{+0.7}_0$	12.5	26	BD
125	125 $^{+1.2}_0$	4.8 $^{+0.7}_0$	12.5	26	BD
150	160 $^{+1.5}_0$	6.2 $^{+0.9}_0$	12.5	26	BD
200	200 $^{+1.8}_0$	6.2 $^{+0.9}_0$	16	33	B
200	200 $^{+1.8}_0$	7.7 $^{+1.0}_0$	12.5	26	BD
250	250 $^{+2.3}_0$	7.7 $^{+1.0}_0$	16	33	B
250	250 $^{+2.3}_0$	9.6 $^{+1.2}_0$	12.5	26	BD
300	315 $^{+2.9}_0$	9.7 $^{+1.2}_0$	16	33	B
300	315 $^{+2.9}_0$	12.1 $^{+1.5}_0$	12.5	26	BD

Note: The tolerances indicated are specified in the reference standard EN 1519.

Connection systems

Different methods can be used for connecting the pipes and/or fittings in polyethylene:

- Connection by butt-welding.
- Electrofusion coupling.
- Connection by push-fit socket.
- Connection by expansion sockets.
- Connection by threaded fittings.
- Connection by contraction sleeves.
- Connection by screw fittings.
- Connection by screw fittings and flange bushing.
- Connection by flanged fittings.

For more information on connection methods see chapter 8 “Connections and testing”.

Marking

Figure Pipe marking.

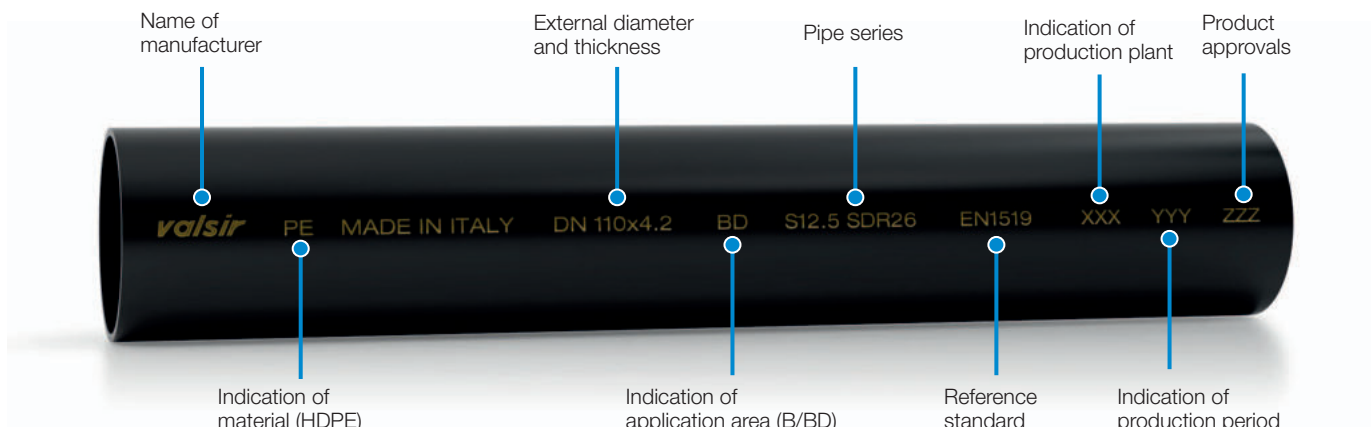
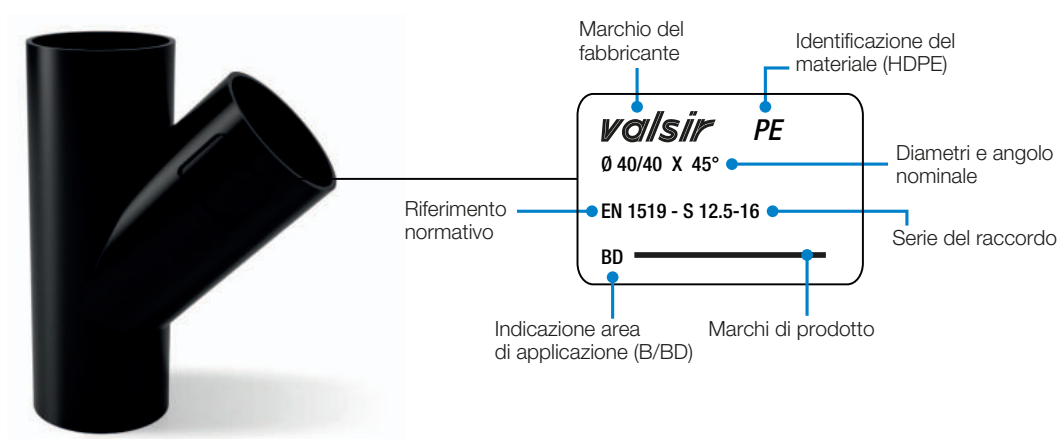

Figure Fitting marking.



Outlets



- Product reference: Rainplus® siphonic roof outlet
- Rainplus® siphonic roof outlet construction: siphonic outlets composed of body, compression flange and anti-vortex plate made of aluminum coated by a special protective paint, an anti-leaf grating made of UV resistant polypropylene with a load resistance of at least 200 kg and a socket for connection to Valsir HDPE pipes with a safety device and two ring seals.
- A stainless steel plate must be used for installation in gutter. The aluminum flange compresses the stainless steel plate on both sides where two rubber seals guarantee the water tightness. The stainless steel plate must be welded or properly riveted to the gutter with proper mastic for water sealing.
- A galvanized steel plate must be used when waterproofing membranes (such as TPO, PVC, bitumen) are used on the roof. The aluminum flange compresses the membrane on the plate and a rubber seal guarantees the water tightness.
- Stainless steel screws are used for water-tightness of the roof/gutter construction.
- Outlet tested by recognized independent testing Laboratory LGA-TUV in Würzburg (Germany) for compliance with the performance requirements for siphonic drainage in accordance with EN 12056-3, EN 1253, and ASME A112.6.9.
- Accessories: Thermo-Kit for ice melting, Overflow-Kit for emergency secondary siphonic systems.
- Installation and maintenance: to be as per the relevant Valsir Rainplus® instructions.

Rainplus 110

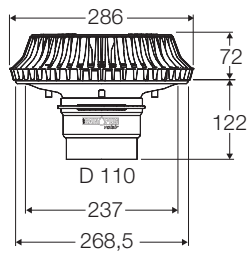

Table Technical data Rainplus 110

Model	Rainplus 110
Connection type	Vertical
Connection size	110 mm
Maximum flow rate	65 l/s
Material of body	Aluminum coated with black epoxy paint
Material of flange	Aluminum coated with black epoxy paint
Material of antivortex plate	Aluminum coated with blue epoxy paint
Material of connection	HDPE (High density polyethylene)
Material of leaf guard	PP (Polypropylene)
Material of seals	EPDM (2 o-rings)
Material of safety clip	Stainless steel coated with red epoxy paint
Overflow	Optional
Heating kit	Optional
Roof connector	Optional (520x520 mm stainless steel flange)
Gutter connector	Optional (320x320 mm stainless steel flange)
Standards	ASME A112.6.9, DIN EN 1253

Figure Valsir Rainplus® 110 outlet. Drawings

COD. VS0420001



COD. VS0420001 +
COD. VS0420151

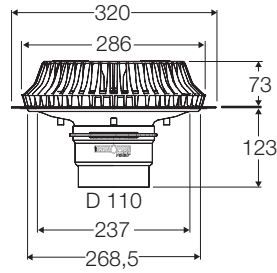

COD. VS0420001 +
COD. VS0420150

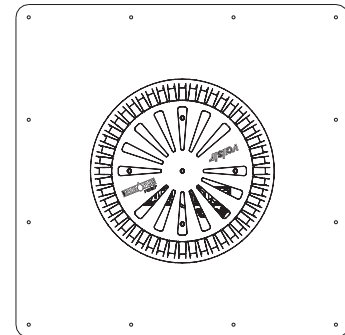
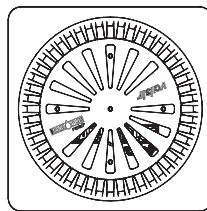
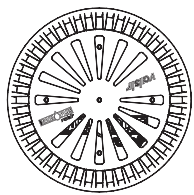
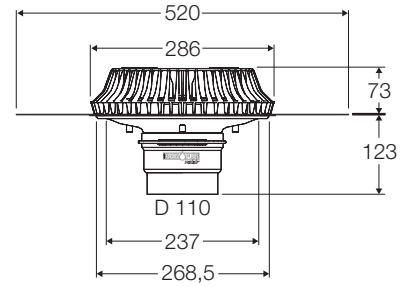
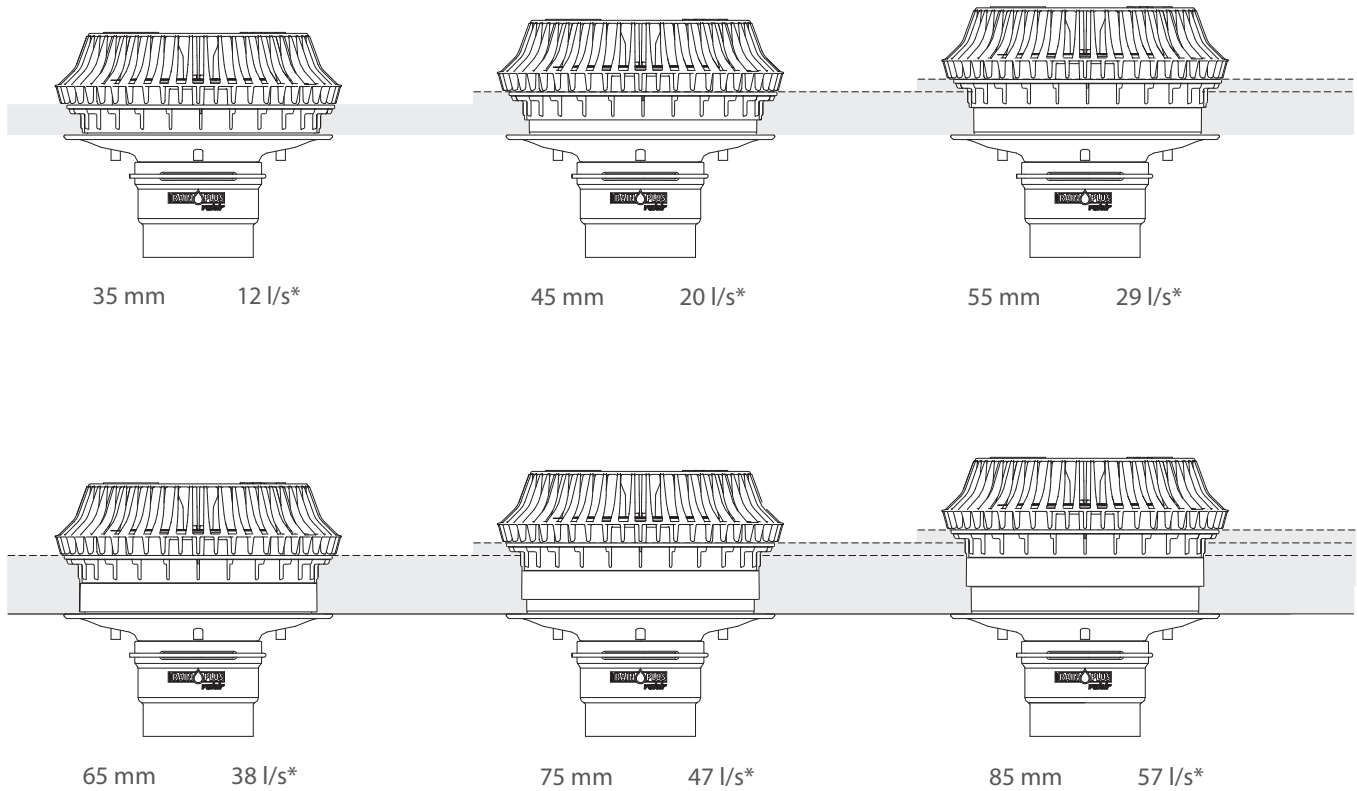

Figure Valsir Rainplus® 110 outlet. Overflow (Optional) Settings



* Max. flow rate on the primary circuit.

Rainplus 56

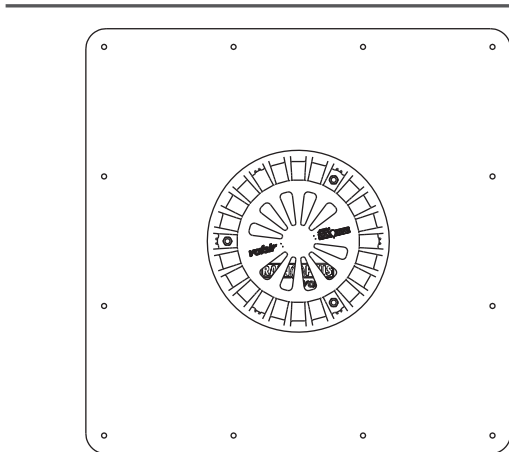
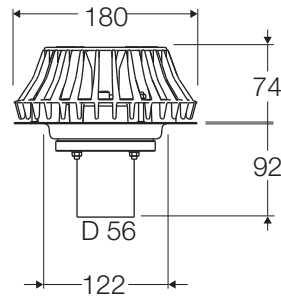
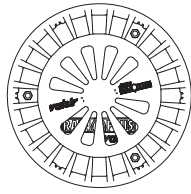

Table Technical data Rainplus 56

Model	Rainplus 56
Connection type	Vertical / Horizontal
Connection size	56 mm
Maximum flow rate	14 l/s
Material of body	Stainless steel
Material of flange	Stainless steel
Material of antivortex plate	Aluminum coated with blue epoxy paint
Material of connection	HDPE (High density polyethylene)
Material of leaf guard	PP (Polypropylene)
Material of seals	EPDM seal
Overflow	Optional
Heating kit	Optional
Roof connector	420x420 mm stainless steel flange
Gutter connector	Ø 180 mm stainless steel flange
Standards	ASME A112.6.9, DIN EN 1253

Figure Valsir Rainplus® 56 outlet. Drawings

COD. VS0420005



COD. VS0420015

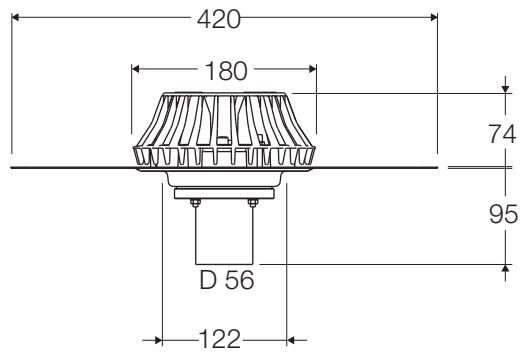
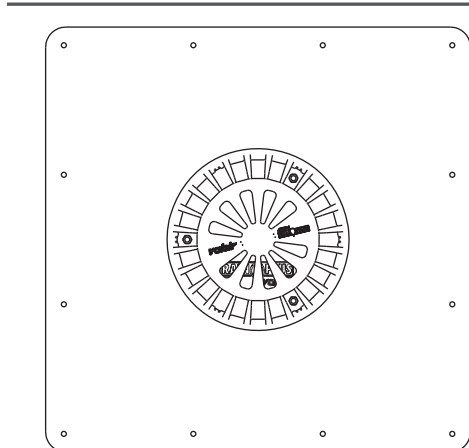
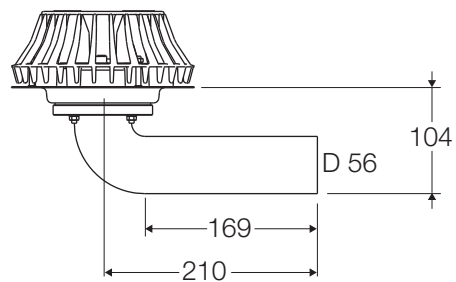
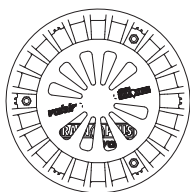

Figure Valsir Rainplus® 56 outlet. Drawings

COD. VS0420007



COD. VS0420017

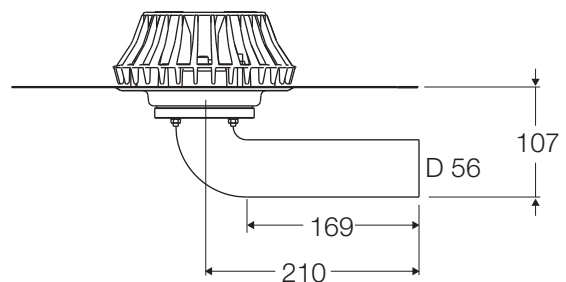
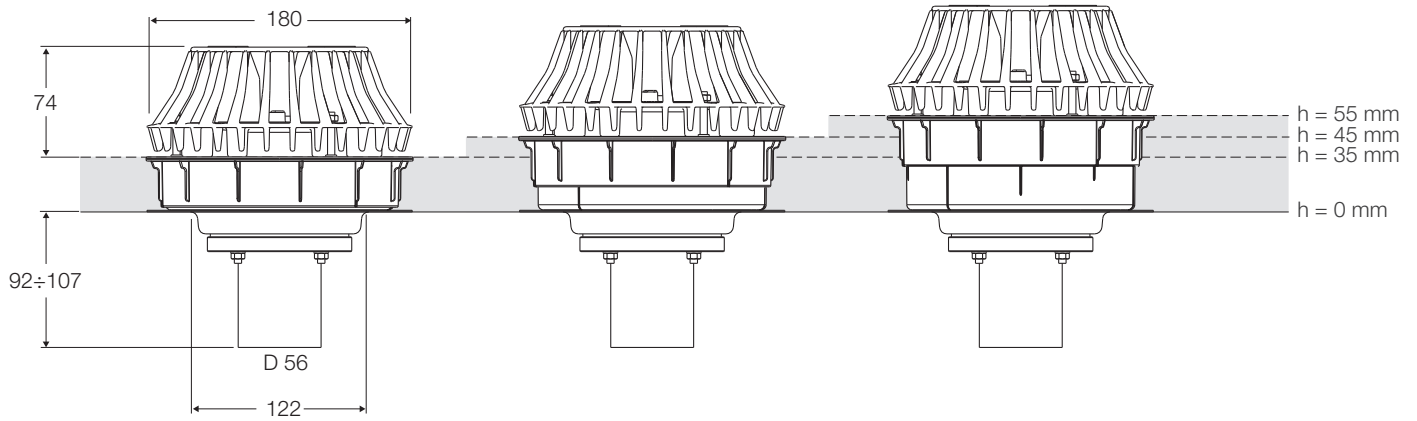

Figure Valsir Rainplus® 56 Overflow (Optional) Settings

COD. VS0420057



* Max. flow rate on the primary circuit.



Recyclable products and low impact production processes in line with Green Building principles.

MAINTENANCE

General

Siphonic system doesn't require any mechanical, electrical or moving parts. To keep the system operating at its full design performance, a regular and periodic maintenance should be put in place.

The Valsir Rainplus® Siphonic Roof Drainage System operates at high velocities within the piping system and, as direct result of this, the drainage pipes are self-cleaning. However, a periodic maintenance is highly recommended to keep the Siphonic Rainwater System working efficiently. This should be undertaken at least three times per year, in any case the maintenance frequency must be according to the climate and ambient conditions of the place where the drainage system is operating (presence of high trees, birds, sand, etc.).

Cleaning roof areas and gutters.

The siphonic system must operate to its maximum efficiency and for this reason the water flowing into the outlets should be unrestricted, for this reason it is important to check all gutters and flat roof areas are free from obstructions such sand, plastic bags, leaves, debris, etc.

When cleaning the roof and the gutters, the debris must be removed from the roof and absolutely not thrown in the outlets. Debris, leaves, sand, etc. must be removed and moved to the ground level to avoid the risk of having them spread again all around the roof or the gutters.

Cleaning outlets.

Valsir Rainplus® siphonic outlets must be cleaned respecting the following instructions (also contained in the outlet package). Each siphonic outlet has an blue anti-vortex plate to aid the siphonic action and a black leafguard to prevent debris entering the system.

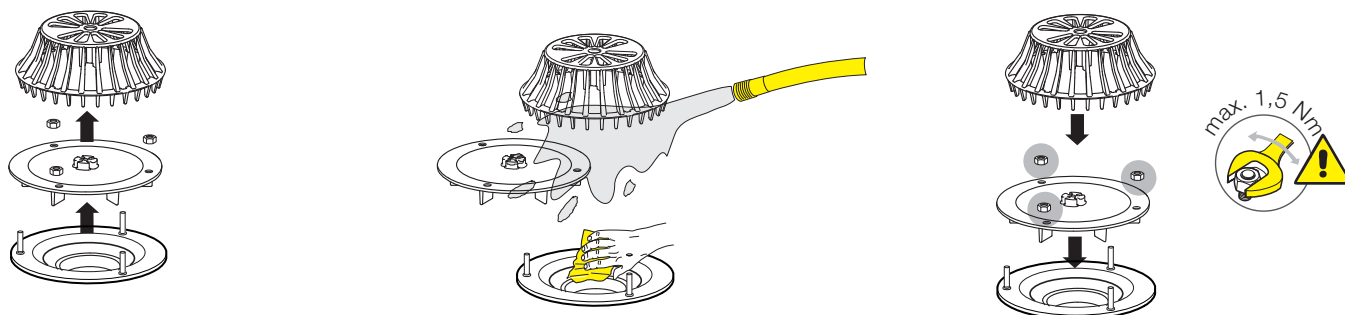

After gutter and roof cleaning works, the siphonic outlet maintenance is required, to do that the following steps must be done:

- Clear all debris, leaves, sand, etc. accumulated around the leafguard and remove from the roof, always ensure debris is not allowed to enter the pipes through the outlets.
- Remove the leafguard and the blue anti-vortex plate (step 1) ensuring debris is not allowed to enter the system.
- Check visually there are no blockages in the pipe connected to the outlet. One sign of a possible blockage is standing water in the outlet body.
- Wash and clean (step 2) the blue anti-vortex plate, the leafguard, screws, nuts and the outlet body.
- Replace the blue anti-vortex plate and tighten the screws/nuts. Locate the leafguard under the anti-vortex plate and clip it, tighten the screw.

PLUMBING

WASTE SYSTEMS



SUPPLY SYSTEMS



GAS SYSTEMS



FLUSH SYSTEMS



BATHROOM SYSTEMS



TRAPS



RADIANT SYSTEMS



DRAINAGE SYSTEMS



HRV SYSTEM



ACADEMY



SEWER SYSTEMS



WATER TREATMENT



BUILDING

valsir[®]
QUALITY FOR PLUMBING

VALSIR S.p.A.
Località Merlaro, 2
25078 Vestone (BS) - Italy
Tel. +39 0365 877.011
Fax +39 0365 81.268
e-mail: valsir@valsir.it

www.valsir.com

Soggetta all'attività di direzione e coordinamento ex art. 2497 bis C.C. da parte di Silmar Group S.p.A. - Codice Fiscale 02075160172